



PST-360: Instructions for use

HOW TO ORDER: **PST360G2-1A-C0007-ERA180-05K**

OUTPUT TYPE: **Simple - Analog (ratiometric)**

SIGNAL OUTPUT **10% to 90% Vdd (180° ERA)**

ROTOR: **14mm**

OUTPUT FUNCTION: **Curve 0007**

SUPPLY VOLTAGE: **5V ± 10%**

TEMPERATURE: **-40 °C to +125 °C**

Connections scheme:

Wire color	Connection	Recommended connections
Brown	Power supply Vdd: 5V ± 10%	
Blue	Ground	
Black	Signal output Vout: 10% to 90% Vdd (180° ERA)	

⚠ WARNING

-In order to minimize the possibility of short circuits, we recommend to connect the power supply at the end

Signal output:

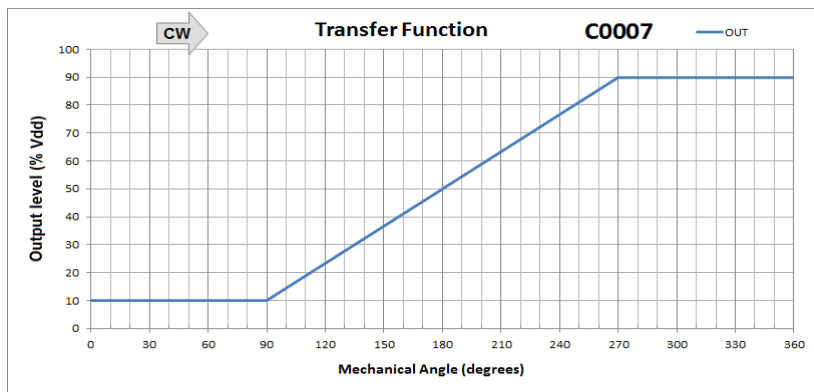

Reference position:

Rotor is shown at zero position

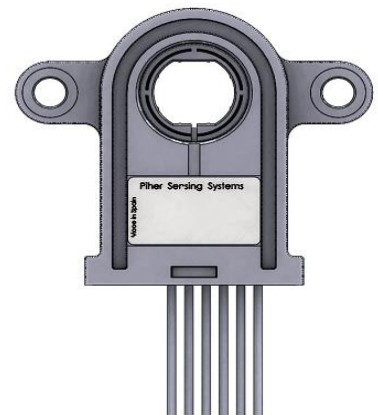

CLOCKWISE



Information contained in and/or attached to this document may be subject to export control regulations of the European Community, USA, or other countries. Each recipient of this document is responsible to ensure that usage and/or transfer of any information contained in this document complies with all relevant export control regulations. If you are in any doubt about the export control restrictions that apply to this information, please contact the sender immediately. For any Piher Sensors & Controls SA Exports, Note: All products / technologies are EAR99 Classified commodities. Exports from the United States are in accordance with the Export Administration Regulations. Diversion contrary to US law is prohibited.

To get more information about our full Legal Disclaimer and Limitation of Liability please visit www.piher.net/disclaimer_hollow_shaft.pdf.

Users acknowledge that they have read this legal disclaimer and agree to abide by its terms.

Piher Sensors & Controls SA ***** confidential *****
Poligono Industrial Municipal, Vial T2, No 22, 31500 Tudela, Navarra, Spain

Tel: +34 948 820 450
Fax: +34 948 824 050
www.piher.net

Piher is an Amphenol[™] company.
RM Navarra Tomo 551, Folio 7, Hoja 5.580
CIF/VAT ESA31169907