

Magnetic rotary angle and position sensor-control

Contactless sensor PSC-360



The robust PSC-360 is a cost effective high performance non-contacting rotary position sensor for automotive, off-road, marine, medical and industrial applications without the limitations of potentiometric solutions (wear, limited electrical angles...). A configurable switch output, as an option, integrated within the sensor is available too.

Redundancy can be achieved by employing a dual die version providing independent voltage outputs with fully customized characteristics providing the possibility to detect error outputs by the host electronics.

Sealed for harsh environments and flange mounted for easy positioning when necessary, it provides high stability under harsh environment conditions such as vibration, shock, extreme temperatures / humidity, dither, moisture or dirt. Available with fly leads, can be customized to customer's needs to any desired connector configuration.

Mechanical specifications

Rotational life (depends on application and mounting)	up to 50.000.000 cycles.
Operating temperature ¹	-40°C to +125°C.

Electrical specifications

Linearity ¹	±1% absolute (0.5% upon request).
Angular range	Programmable from 15 to 360 degrees.
Output	Analog (Ratiometric), PWM. Serial Protocol upon request.
Switch output	Upon request. Programmable.
Angular Resolution (depends on electrical angle and rotational speed)	Analog & PWM: up to 12 bits. Serial Protocol (SPI): up to 14 bits.
Supply voltage ¹	Up to 25V.
Supply current	Typ 8.5mA for single version. Typ 17mA for redundant version.

¹ Others: check availability.

Key features

- Simple and robust magnetic design.
- High resolution (up to 14-bit).
- Ratiometric analog or PWM outputs.
- Absolute position feedback up to 360° (keeps position on power loss).
- True full redundant version.
- Sealed construction for harsh environments such as off-highway and marine.
- Protected from dust, moisture, vibration and extreme temperatures.
- Endless rotation.
- Fully programmable transfer function output at the factory with electrical outputs up to 360°.
- Self-diagnostic features.
- Over voltage protection and reverse voltage protection.
- Extended voltage input supply values.

Also upon request:

- Programmable switch output.
- SPI output.
- Lever with return spring.

Industries served

- Automotive and On-highway (road vehicles, trucks, recreational vehicles, road sweepers).
- Off-highway (agriculture, construction and forestry, motorsport, airport operations).
- Material handling.
- Marine engines.
- Medical.
- Industrial.

Applications

- Steering wheel angle sensor.
- Brake and clutch accelerator pedal.
- Arm control.
- Hitch position.
- Throttle control / sensor.
- Bucket position.
- Fork height and mast tilt.
- Transmission gear shifter.
- Suspension and height sensor.
- Steering, accelerator and shifter sensor for marine engine.

Magnetic rotary angle and position sensor-control

Contactless sensor

PSC-360



How to order (example: PSC360G2-F1A-C0000-ERA360-05K)

Simple output (analogic / PWM)

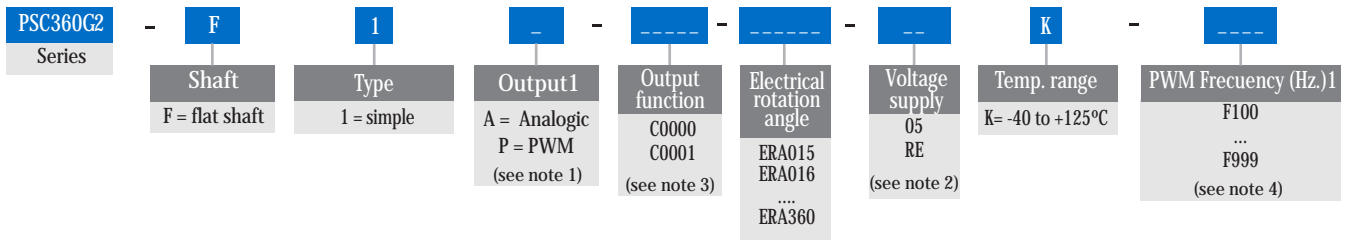

Redundant output (analogic / PWM)

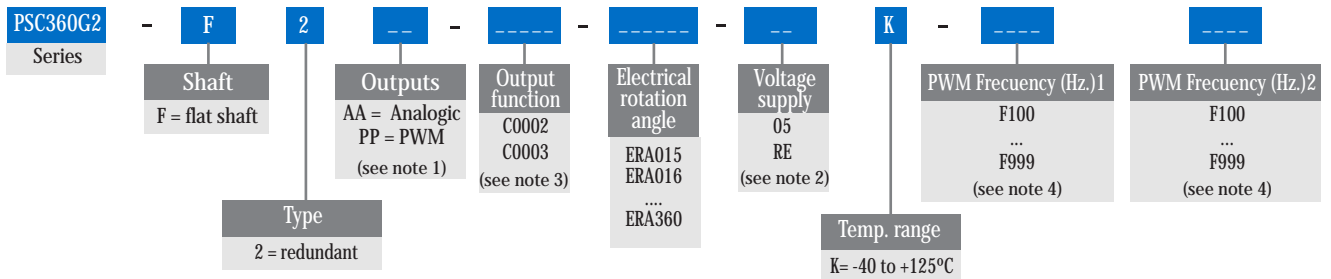

Full redundant output (analogic / PWM)

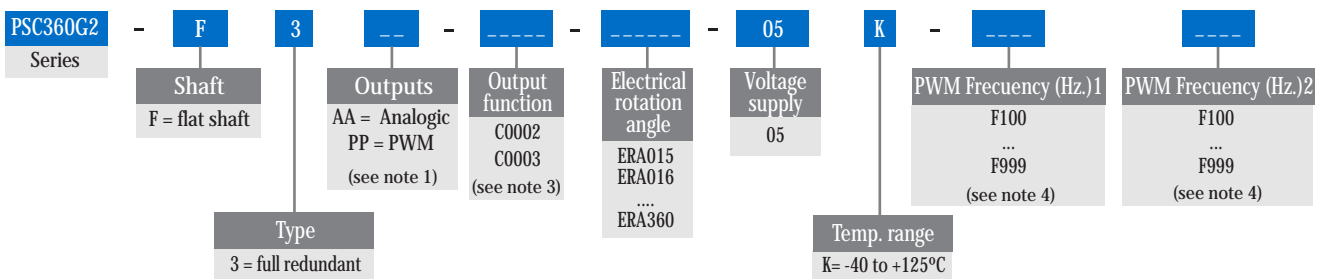

Other product configurations will be studied case by case.

Notes

- (1) The analog output is a ratiometric output, proportional to:
 - For supply voltage 5V: to input supply voltage.
 - For supply voltage RE: to 5V.
- (2) 05: 5V ±10%
RE: 7V - 25V
- (3) Other output functions available check availability. In the How To Order reference, enter CXXXX meanwhile the new output function reference is not defined.
- (4) Leave empty if no applicable. Default frequency is 200 Hz

How to order. - panel mount version (example: PSC360U-F1A-C0000-ERA360-05E)

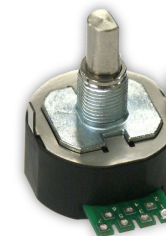

Simple output (analogic / PWM)

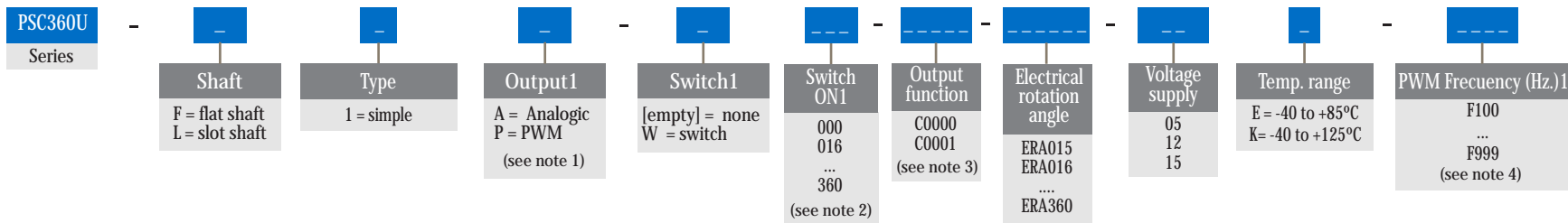

Simple output (SPI)

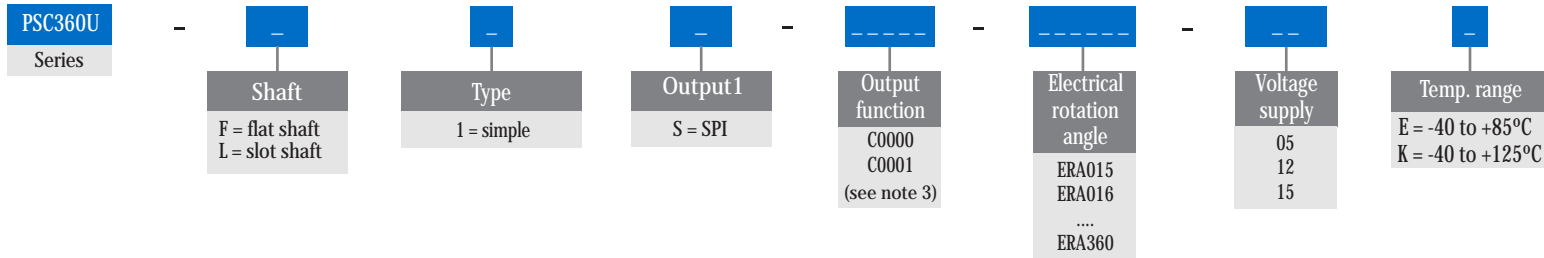

Redundant output (analogic / PWM)

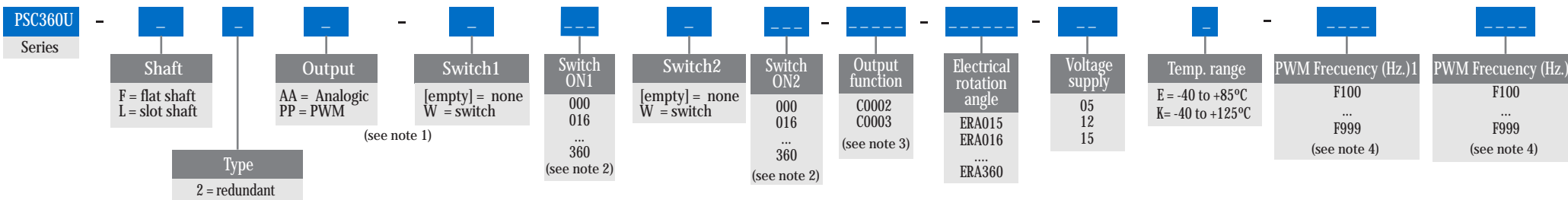

Full redundant output (analogic / PWM)

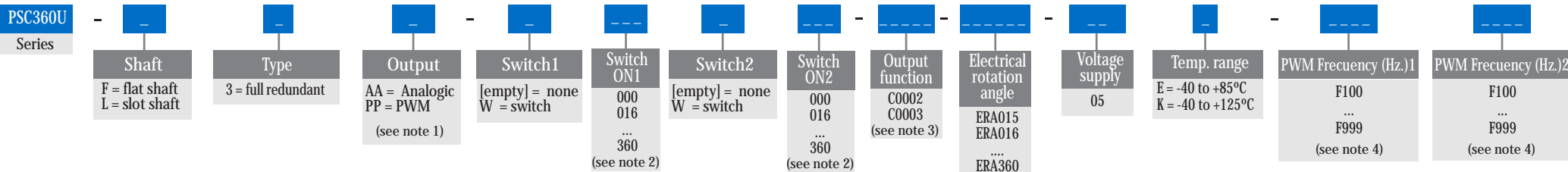

Other product configurations will be studied case by case.

(1) The analog output is a ratiometric output, proportional to:

- For supply voltage 5V: to input supply voltage.
- For supply voltage 12V: to 5V.
- For supply voltage 15V: to 5V.

(2) Leave empty if no applicable. Switch function diagram:



(3) Other output functions available check availability. In the How To Order reference, enter CXXX meanwhile the new output function reference is not defined.

(4) Leave empty if no applicable. Default frequency is 200 Hz

Notes

Magnetic rotary angle and position sensor-control

Contactless sensor PSC-360

Dimensions (mm) - standard version PSC360G2



Download the STEP file here:
<https://piher.net/piher/?p=830>

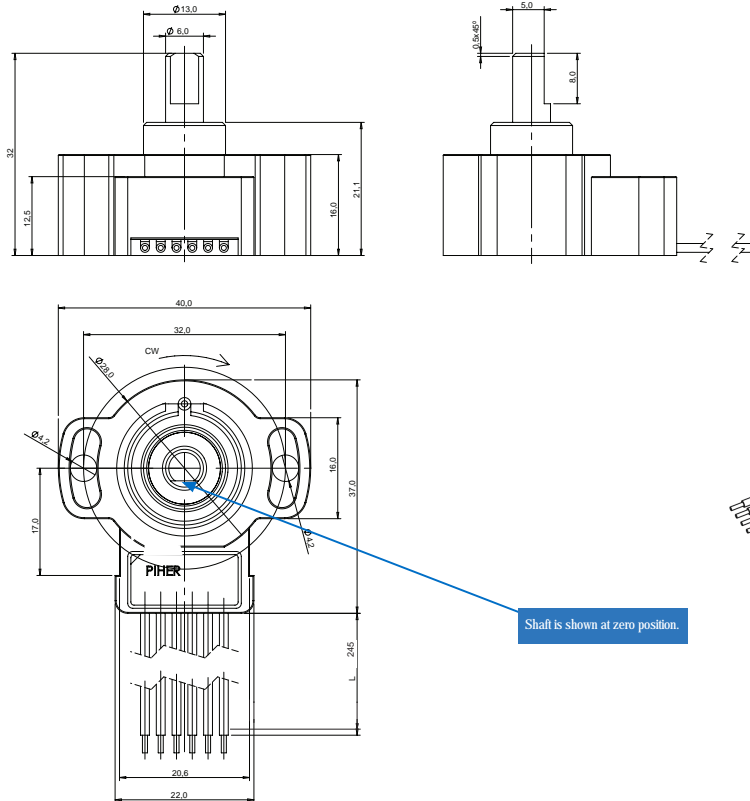

Shaft is shown at zero position.

Dimensions (mm) - Panel mount version PSC360U

* Nut & washer included.



Download the STEP file here:
<https://piher.net/piher/?p=830>

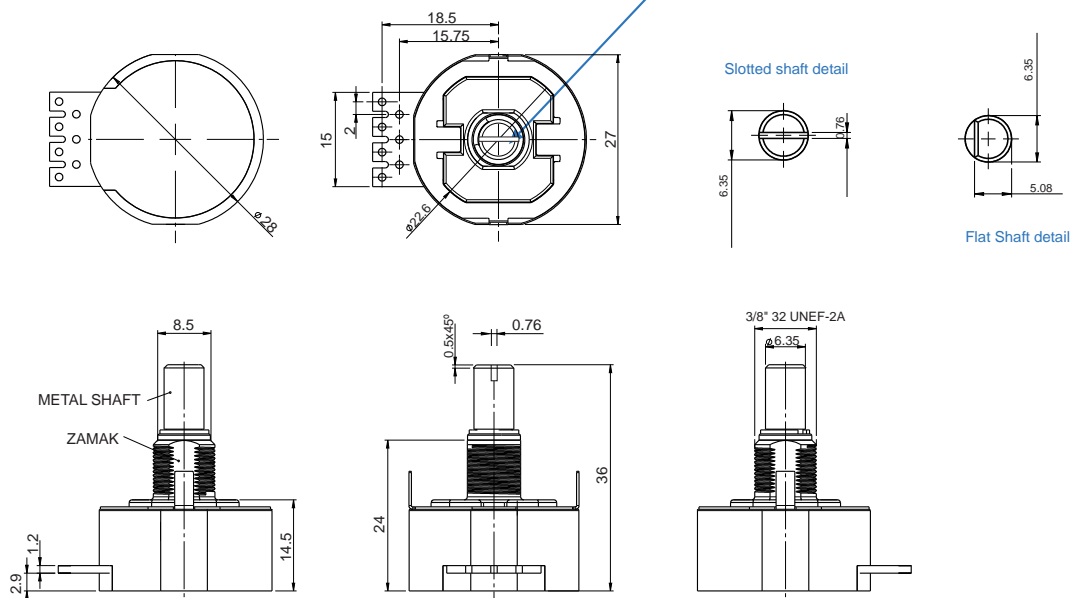

Shaft is shown at zero or 180° position.
Sensor is delivered at random position.

Slotted shaft detail

Flat Shaft detail

Magnetic rotary angle and position sensor-control

Contactless sensor PSC-360

Special versions

If you require special solutions for your application, just contact us. We will put all our know-how and ability into designing the right sensor for you. We Are Passionate. We Love What We Do.



Special version with integrated connector.

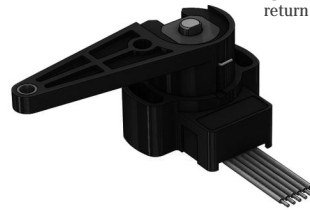

Special design with return spring lever.

Mounting instructions

- 1.- Place the component on a flat surface.
- 2.- Fit the actuator onto the shaft avoiding any mechanical play/wobble.
- 3.- Fasten the two M4 screws (M4 washers are recommended).

Instructions of use available at www.piher.net

Connections scheme

Simple analog output connection wiring scheme for PSC360G2.

- Brown = Power supply.
- Blue = Ground.
- Black = Signal output.
- White = Not used.
- Grey = Not used.

Fly leads with Wire: 0.35mm² TXL SAE J1128.

Other versions available upon request.. Check availability for the connector options.

Output

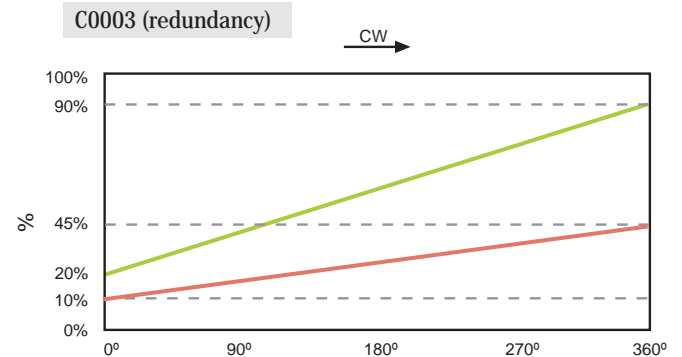
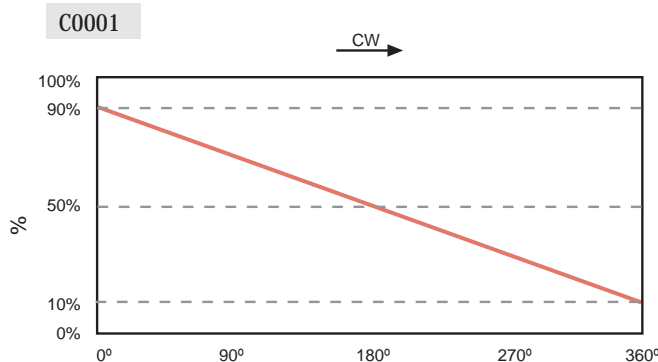
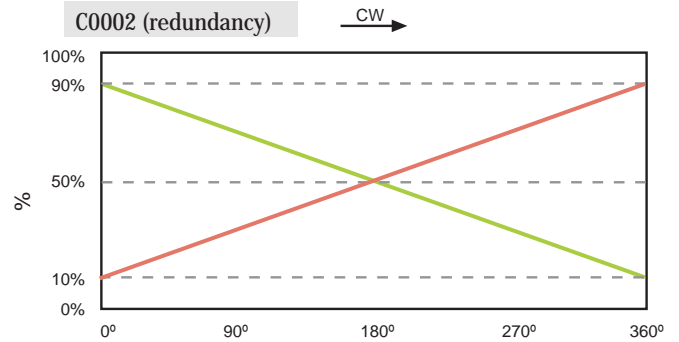
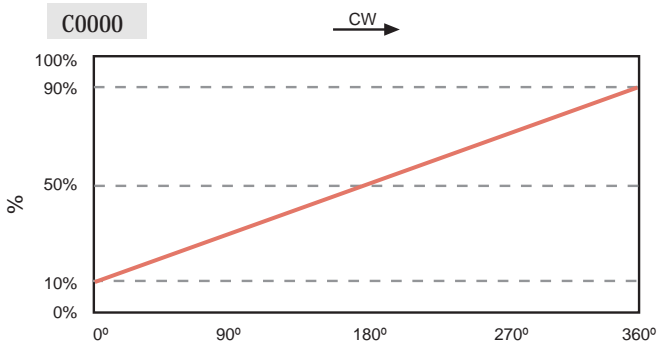

Others upon request.

Piher Sensing Systems

Potentiometers | [Hall-effect sensors](#) | Inductive sensors
Printing electronics | Value added assemblies

PIHER *sensing systems*

Magnetic rotary angle and position sensor-control

Contactless sensor PSC-360

Disclaimer

The product information in this catalogue is for reference purposes. Please consult for the most up to date and accurate design information.

Piher Sensors & Controls S.A., its affiliates, agents, and employees, and all persons acting on its or their behalf (collectively, "Piher"), disclaim any and all liability for any errors, inaccuracies or incompleteness contained herein or in any other disclosure relating to any product described herein.

Piher disclaims any and all liability arising out of the use or application of any product described herein or of any information provided herein to the maximum extent permitted by law. The product specifications do not expand or otherwise modify Piher's terms and conditions of sale, including but not limited to the warranty expressed therein, which apply to these products.

No licence, express or implied, by estoppel or otherwise, to any intellectual property rights is granted by this document or by any conduct of Piher.

The products shown herein are not designed for use in medical, life-saving, or life-sustaining applications unless otherwise expressly indicated. Customers using or selling Piher products not expressly indicated for use in such applications do so entirely at their own risk and agree to fully indemnify Piher for any damages arising or resulting from such use or sale. Please contact authorised Piher personnel to obtain written terms and conditions regarding products designed for such applications.

Product names and markings noted herein may be trademarks of their respective owners.

Information contained in and/or attached to this catalogue may be subject to export control regulations of the European Community, USA, or other countries. Each recipient of this document is responsible to ensure that usage and/or transfer of any information contained in this document complies with all relevant export control regulations. If you are in any doubt about the export control restrictions that apply to this information, please contact the sender immediately. For any Piher Exports, Note: All products / technologies are EAR99 Classified commodities. Exports from the United States are in accordance with the Export Administration Regulations. Diversion contrary to US law is prohibited.

Piher is an Amphenol™ company.

Contact

Piher Sensors & Controls SA
Poligono Industrial Municipal
Vial T2 N°22
31500 Tudela - Spain
Tel: +34-948-820450

sales@piher.net

www.piher.net



RoHS
compliant



All Piher products can be adapted to meet customer's requirements.
Due to continuous process improvement, specifications are subject to change without notice.
Please always use the datasheets published at our website www.piher.net for the most up-to-date information.

rev110620

Piher Sensing Systems

Potentiometers | [Hall-effect sensors](#) | Inductive sensors
Printing electronics | Value added assemblies

PIHER *sensing*
systems